



BB60BR-L1-XS(LR)



NSF standard 7 listed for storage of non-hazardous bottled and canned products only

Project: _____	AIA# _____
Item #: _____ Qty: _____	SIS# _____
Model #: _____	

**Two Zone Back Bar Coolers
Two, Three, and Four Door,
Self-Contained**

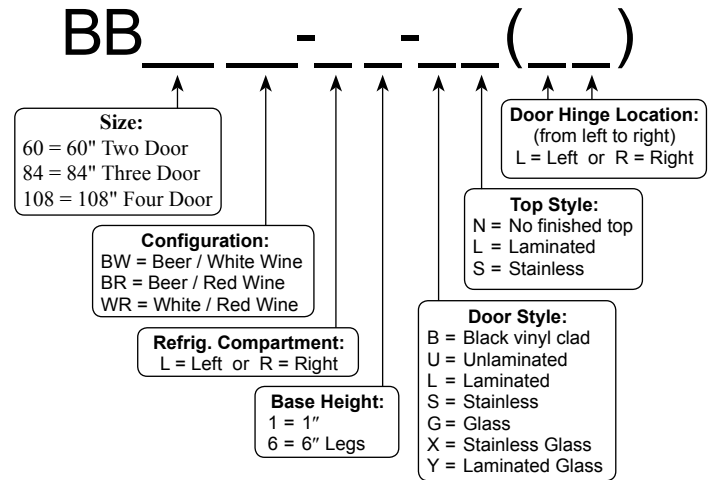

Standard Features

- Available in three configurations: beer and white wine, beer and red wine, or white wine and red wine
- Available with compressor located left or right. The warmer of the two compartments is always a single door and located opposite the compressor end.
- The two temperature zones are independently controlled
- Self-contained
- All stainless steel interior construction with radius interior corners for easy cleaning
- CFC free foamed-in-place insulation
- Black vinyl-clad steel exterior front and sides
- Automatic defrost timer
- Automatic condensate evaporator
- Leg sockets recessed into base
- 1/2" thick ABS plastic threshold scuff plate
- 180° swinging doors

Specifications

Electrical

- 120V, 1 phase, 60 Hz, 6.5 full load amps
- Dedicated 15 amp circuit is required
- Includes a 6 foot grounded cord and plug which exits the back of refrigeration compartment

Refrigeration

- R134a
- 1/3 HP

Operating Range

- Beer compartment: 34°F to 40°F
- White wine compartment: 50°F to 55°F
- Red wine compartment: 60°F to 65°F

Plumbing

- Automatic condensate evaporator. No drain connection required

Shelving

- Two adjustable coated shelves and one bottom coated rack per door included
- Part #06006264 wine rack shelf with 7 slots is available as an accessory

Legs

- 1-5/8" diameter
- Stainless steel bullet feet

Capacity

- 7 cases long neck beer bottles per door or 66 750ml wine bottles per door

Materials

- 22 gauge stainless steel parts include: interior floor, walls, ceiling, front of cabinet, and evaporator housing
- 22 gauge black vinyl-clad parts include: sides, standard doors, and compressor compartment housing
- 22 gauge galvanized steel parts include: exterior sub-top and back
- 16 gauge stainless steel parts include: legs
- 16 gauge galvanized steel parts include: base and compressor compartment base plate
- 16 gauge zinc plated CR steel parts include: leg sockets
- 12 gauge stainless steel parts include: hinges, hinge brackets, and lock brackets

<p>Glastender, Inc. • 5400 N Michigan Rd • Saginaw, MI • 48604-9780 989.752.4275 • 800.748.0423 • Fax 989.752.4444 www.glastender.com</p>	Approval/Notes:
--	-----------------

Specifications subject to change without notice. For current specifications please visit our website.

Self-Contained Two Zone Back Bar Coolers

Dimensional Information

BB60BW, BB60BR, and BB60WR

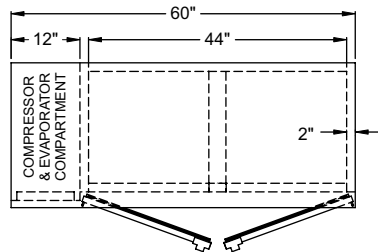

Plan View

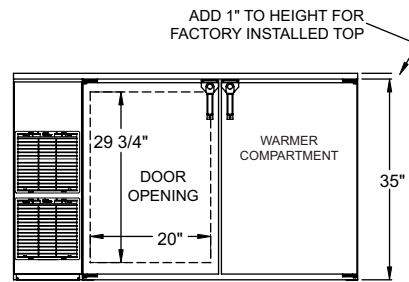

Front Elevation

BB84BW, BB84BR, and BB84WR

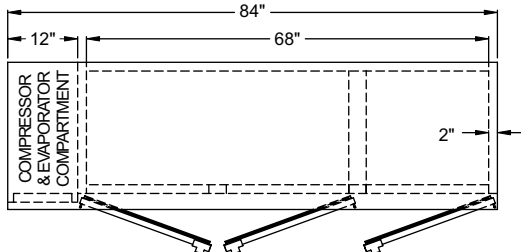

Plan View

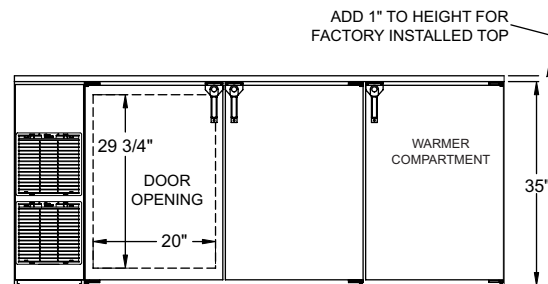

Front Elevation

BB108BW, BB108BR, and BB108WR

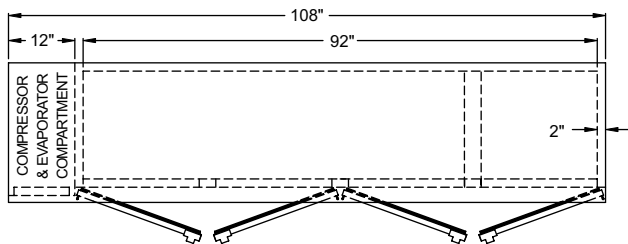

Plan View

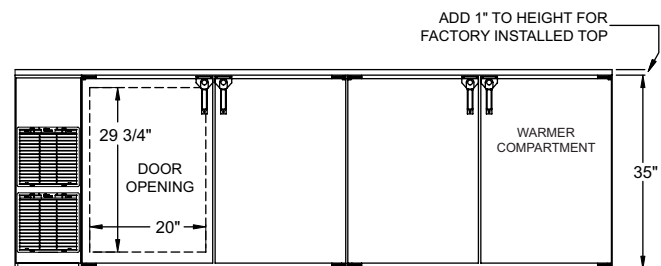

Front Elevation

Side View All Models

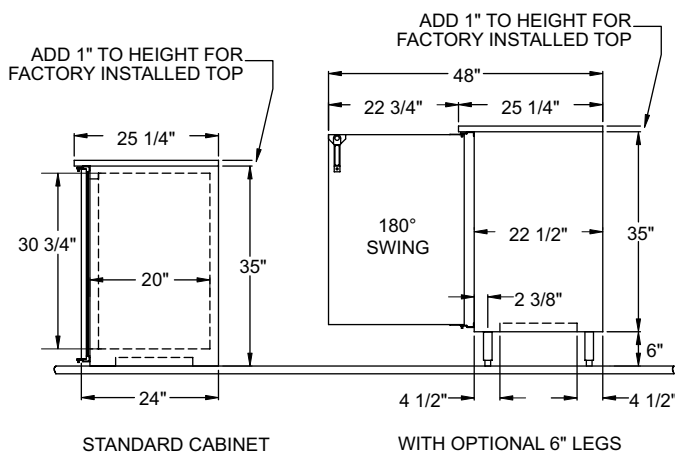

STANDARD CABINET

WITH OPTIONAL 6" LEGS



06006264 Accessory Wine Rack Shelf for BB, stainless steel with slots for 7 bottles